

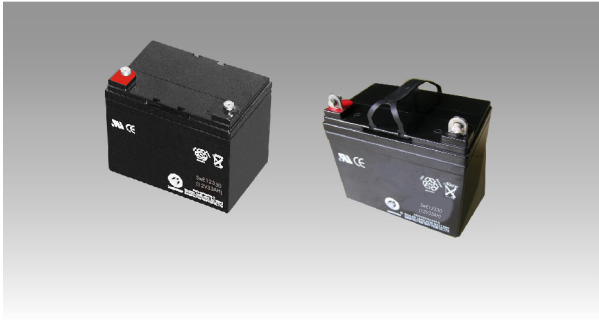

SWE12330(12V33AH)

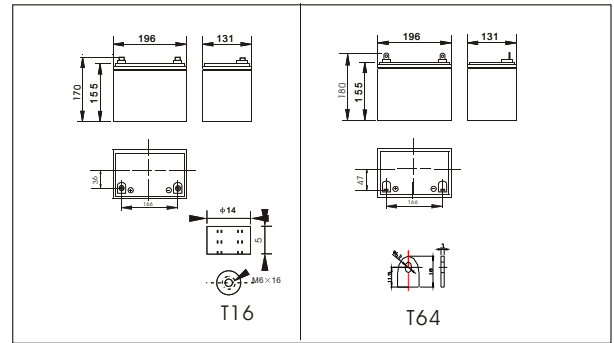

Outer dimensions (mm)



Specifications

Nominal Voltage		12V
Rated capacity (10 hour rate)		33 Ah
Dimensions	Total Height	179 mm (7.05 inches)
	Height	163mm (6.42 inches)
	Length	196 mm (7.72 inches)
	Width	130mm (5.12 inches)
Weight Approx		10.0Kg (22.0lbs)

Curves of cycle life(25°C)

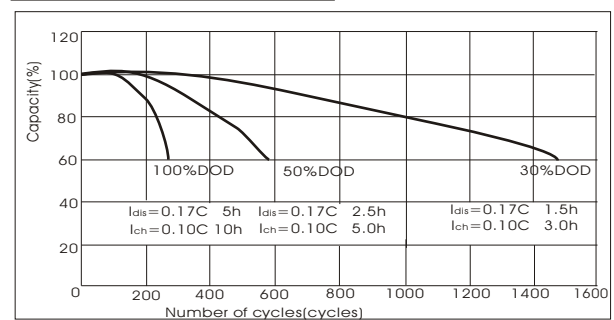

Characteristics

Capacity 25°C(77°F)	10 hour rate(3.0A) 5 hour rate(4.8A) 1 hour rate(18.0A)	33.0 AH 26.5 AH 19.8 AH
Internal Resistance	Full charged Battery at 25°C(77°F)	Approx 9.2 m Ω
Capacity affected by Temperature (10hour rate)	40°C(104°F) 25°C(77°F) 0°C(32°F) -15°C(5°F)	102% 100% 85% 65%
Self-Discharge at 25°C(77°F)	Capacity after 3 month storage Capacity after 6 month storage Capacity after 12 month storage	91% 82% 64%
Terminal	T64、T16	
Charge (constant Voltage)	Cycle	Initial Charging Current less than 13.2 A Voltage 14.10-14.40V
	Float	Voltage 13.50-13.80V

Discharge Curves 25°C(77°F)

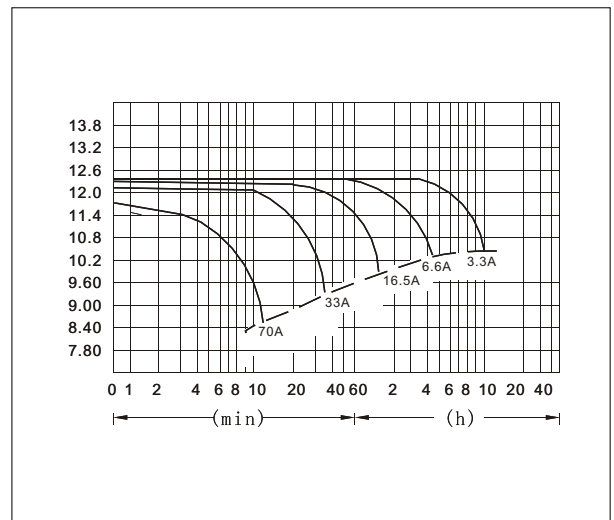

Constant Current(Amp) and Constant Power(Watt) Discharge Table at 25°C(77°F)

Time		5min	10min	15min	30min	1h	2h	3h	4h	5h	8h	10h	20h
9.60V	A	106	70	56	37.6	19.8	11.6	8.5	6.6	5.4	3.86	3.47	1.87
	W	1091	744	602	404	214	127	94	74	62	44	40	21.8
10.20V	A	102	63	53	36.0	18.6	11.0	8.3	6.4	5.3	3.76	3.40	1.82
	W	1093	702	592	404	211	127	96	75	62	44	40	21.3
10.50V	A	99	56	46	33.7	18.0	10.8	8.1	6.3	5.3	3.73	3.33	1.82
	W	1081	639	528	387	209	125	94	74	62	44	39	21.5
10.80V	A	95	53	43	31.0	17.4	10.5	7.9	6.2	5.1	3.63	3.30	1.78
	W	1071	611	495	359	203	123	93	74	61	43	39	21.2
11.10V	A	92	50	40	27.7	16.8	10.2	7.6	6.1	5.0	3.53	3.14	1.68
	W	1046	575	462	324	198	121	90	72	60	42	37.8	20.4