

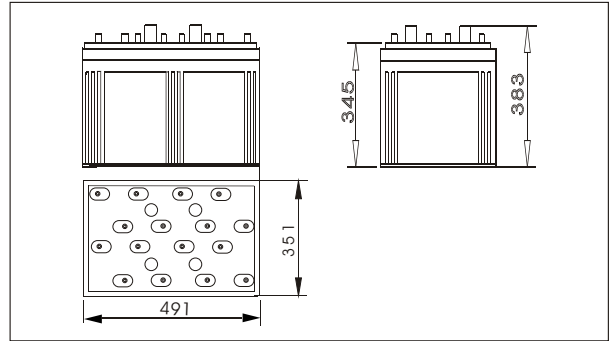

SW220000E(2V2000AH)



● Outer dimensions (mm)



● Specifications

Nominal Voltage		2 V
Rated capacity (10 hour rate)		2000 Ah
Dimensions	Total Height	383mm (15.1 inches)
	Height	345mm (13.6 inches)
	Length	491 mm (19.3 inches)
	Width	351 mm (13.8 inches)
Weight Approx		131 Kg (288.5lbs)

● Terminal Type (mm)

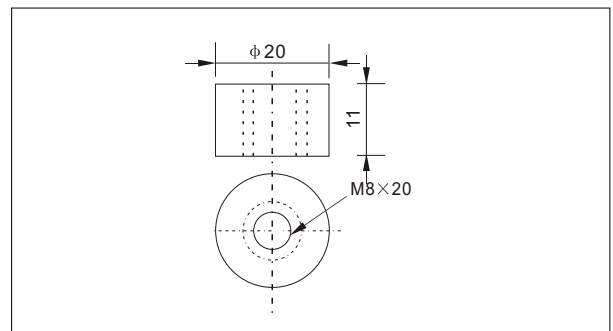

● Characteristics

Capacity 25°C(77°F)	10 hour rate(200 A)	2000 AH
	5 hour rate(320 A)	1600 AH
	1 hour rate(1100 A)	1100 AH
	1.5 hour discharge to 1.75 V	800 A
Internal Resistance	Full charged Battery at 25°C(77°F)	1.5 mΩ
Capacity affected by Temperature (10hour rate)	40°C(104°F)	102%
	25°C(77°F)	100%
	0°C(32°F)	85%
	-15°C(5°F)	65%
Self-Discharge at 25°C(77°F)	Capacity after 3 month storage	91%
	Capacity after 6 month storage	82%
	Capacity after 12 month storage	64%
Terminal		T20
Charge (constant Voltage)	Cycle	Initial Charging Current less than 500 A Voltage 2.35-2.40V
	Float	Voltage 2.25-2.30V

● Discharge Curves 25°C(77°F)

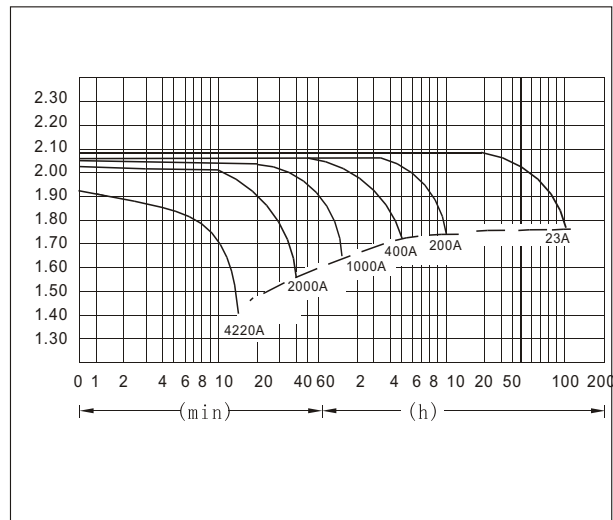

Constant Current(Amp) and Constant Power(Watt) Discharge Table at 25°C(77°F)

Time		10min	30min	1h	3h	4h	5h	8h	10h	20h	50h	100h
1.60V	A	4220	2280	1200	514.0	400.0	330.0	232.6	210.0	113.40	47.2	24.2
	W	7810	4071	2316	992	772	637	449	405	218.9	93.7	48.0
1.70V	A	4100	2220	1128.0	500.0	390.0	324.0	227.6	204.8	110.60	45.6	23.6
	W	7512	4033	2177	965	753	625	439	395	213.5	90.3	46.7
1.75V	A	3918	2112	1092	488.0	384.0	320.0	226.0	200.0	109.20	44.8	23.0
	W	7280	3807	2108	942	741	618	436	391	210.8	89.0	56.7
1.80V	A	3660	2042	1056	476.0	378.0	312.0	220.0	195.0	108.00	44.0	22.8
	W	6997	3663	2015	923	726	605	427	388	209.5	87.3	45.3
1.85V	A	3360	1880	994	460.0	366.7	304.0	214.0	190.00	102.60	43.2	22.0
	W	6877	3633	1962	912	722	603	424	377	203.5	85.7	43.7